

MODEL
CBEB

1.5:1 pilot ratio, standard capacity counterbalance valve
CAPACITY: 120 L/min. | **CAVITY:** T-2A

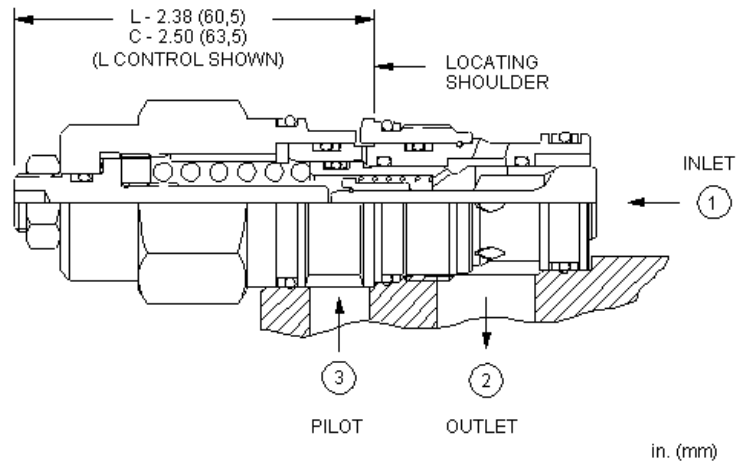
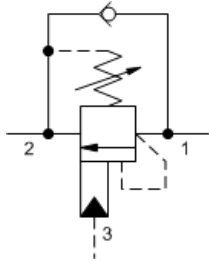

CONFIGURATION

L	Control	Standard Screw Adjustment
H	Functional Setting Range	1000 - 4000 psi w/25 psi Check (70 - 280 bar w/1,7 bar Check), 3000 psi (210 bar) Standard Setting
N	Seal Material	Buna-N
(none)	Material/Coating	Standard Material/Coating

Counterbalance valves with pilot assist are meant to control an overrunning load. The check valve allows free flow from the directional valve (port 2) to the load (port 1) while a direct-acting, pilot-assisted relief valve controls flow from port 1 to port 2. Pilot assist at port 3 lowers the effective setting of the relief valve at a rate determined by the pilot ratio.

Other names for this valve include motion control valve and over center valve.

TECHNICAL DATA

Cavity	T-2A
Series	2
Capacity	120 L/min.
Pilot Ratio	1.5:1
Maximum Recommended Load Pressure at Maximum Setting	215 bar
Maximum Setting	280 bar
Factory Pressure Settings Established at	30 cc/min.
Maximum Valve Leakage at Reseat	0,3 cc/min.
Adjustment - Number of Counterclockwise Turns to Increase Setting	3.75
Operating Characteristic	Standard
Reseat	>85% of setting
Valve Hex Size	28,6 mm
Valve Installation Torque	61 - 68 Nm
Adjustment Screw Internal Hex Size	4 mm
Adjustment Locknut/Cap Hex Size	15 mm
Adjustment Nut Torque	9 - 10 Nm
Seal kit - Cartridge	Buna: 990-202-007
Seal kit - Cartridge	Polyurethane: 990-002-002
Seal kit - Cartridge	Viton: 990-202-006
Model Weight	0.29 kg.

SYMBOLS

3-Port Non-vented

3-Port Non-vented, Fixed Setting

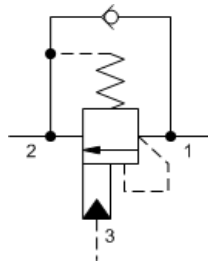
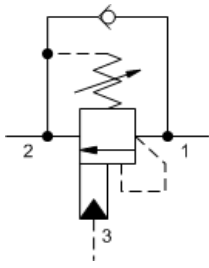

TECHNICAL FEATURES

- Counterbalance valves should be set at least 1.3 times the maximum load induced pressure.
- Turn adjustment clockwise to decrease setting and release load.
- Full clockwise setting is less than 200 psi (14 bar).
- Backpressure at port 2 adds to the effective relief setting at a ratio of 1 plus the pilot ratio times the backpressure.
- Reseat exceeds 85% of set pressure when the valve is standard set. Settings lower than the standard set pressure may result in lower reseal percentages.
- Sun counterbalance cartridges can be installed directly into a cavity machined in an actuator housing for added protection and improved stiffness in the circuit.
- Two check valve cracking pressures are available. Use the 25 psi (1,7 bar) check unless actuator cavitation is a concern.
- This valve has positive seals between all ports.
- All 3-port counterbalance, load control, and pilot-to-open check cartridges are physically interchangeable (i.e. same flow path, same cavity for a given frame size).
- Incorporates the Sun floating style construction to minimize the possibility of internal parts binding due to excessive installation torque and/or cavity/cartridge machining variations.

PERFORMANCE CURVES

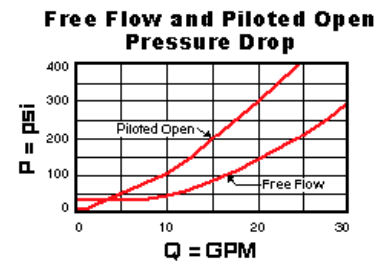
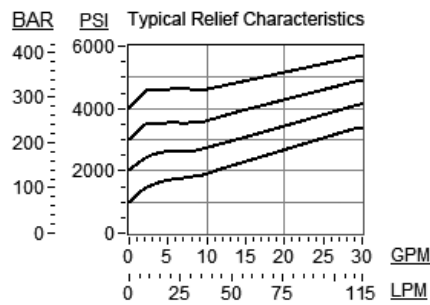
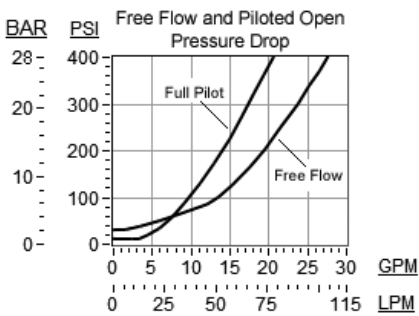

CONFIGURATION OPTIONS

CONTROL

Standard Options	C	Tamper Resistant - Factory Set
	L	Standard Screw Adjustment

FUNCTIONAL SETTING RANGE

Standard Options	A	1000 - 4000 psi w/4 psi Check (70 - 280 bar w/0,3 bar Check), 3000 psi (210 bar) Standard Setting
	B	400 - 1500 psi w/4 psi Check (28 - 105 bar w/0,3 bar Check), 1000 psi (70 bar) Standard Setting
	H	1000 - 4000 psi w/25 psi Check (70 - 280 bar w/1,7 bar Check), 3000 psi (210 bar) Standard Setting
	I	400 - 1500 psi w/25 psi Check (28 - 105 bar w/1,7 bar Check), 1000 psi (70 bar) Standard Setting

SEAL MATERIAL

Standard Options	N	Buna-N
	V	Viton

MATERIAL/COATING

Standard Options		Standard Material/Coating
	/AP	Stainless Steel, Passivated

RELATED MODELS

CBEBX

Model

Copyright © 2002-2014 Sun Hydraulics Corporation. All rights reserved.